



aqa perla

Duplex water softening unit

We thank you for showing your confidence in our products by purchasing a BWT unit.



Table of Contents	Page
Safety Instructions	3
Scope of Delivery	4
Intended Use	4
Function	5
Installation Requirements	5
Installation	7
Quick Guide to Operation	9
Initial Start-Up	10
Checklist	15
Operation	16
Checks	19
Warranty	19
Operator Responsibilities	19
Troubleshooting	20
Standards and Legal Regulations	21
Technical Specifications	22
Machine Log	23
Addresses	Back Page

Safety Instructions



Danger



Note



The power supply unit in the controller is constructed according to DIN 60335. The complete power supply unit must be replaced in event of damage to the mains cable.

Unclean regenerative containers can damage the unit and affect water quality.

Clean the regenerative container with drinking water if it is dirty and at least once a year.

The water-softening unit must be installed as described in the installation guide in compliance with AVB Wasser V, §12.2 (German legal requirements for water supply) by a water supply company or by a party registered in the water supply company's index of fitters.

In keeping with TrinkwV § 16 (German regulations on the preparation of drinking water), notify residents of the installation of the unit and explain how it works and what regenerative is used.

Using retreated drinking water with plants and aquatic animals

Each species of plant and aquatic animal requires water that contains a special combination of substances. Users of the unit should therefore consult the standard literature and check that they can use retreated drinking water for watering plants or for filling ornamental lakes, aquariums or fishponds.

If a power failure occurs when regeneration waste water and overflow are being drained **into a pump system**, flooding could occur.

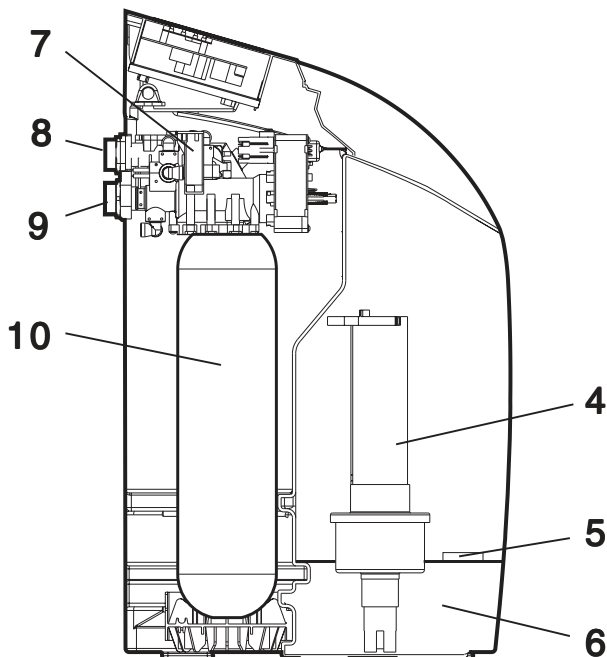
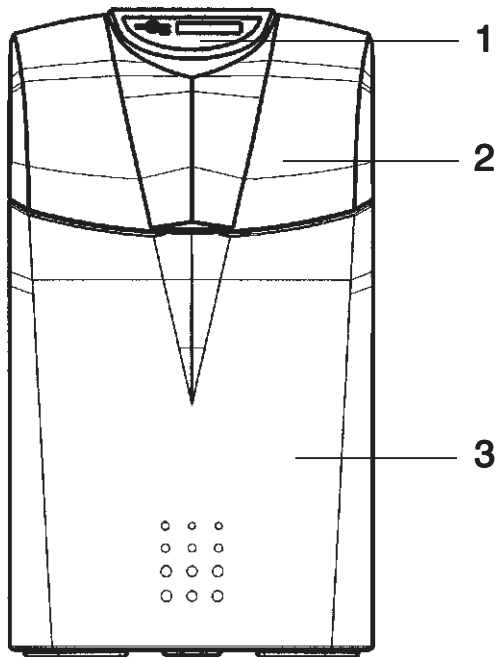

Scope of Delivery

AQA Perla duplex water softening unit with:

- 1 Microprocessor controller
- 2 Cap
- 3 Storage area for regenerative
- 4 Brine dosing tank
- 5 Sieve base with float switch for empty indicator
- 6 Brine cavity
- 7 Multiple-way control valves
- 8 Softened water outlet
- 9 Hard water inlet
- 10 Softening column with ion exchanger

- Power supply unit with cable and mains plug
- 1" connection module
- Multiblock module A
- Connection set DN 32/32 DVGW
- 2m flushing water hose
- 2m overflow hose 18 x 24
- Fixing material
- AQUATEST hardness tester

Optional extras

(not included in scope of delivery):

- Aquastop 3/4" Order no.: 11825
- Aquastop 1" Order no.: 11826

Intended Use

AQA Perla is intended for the softening or partial softening of drinking and service water (according to relevant standards and rulings, DIN 1988, part 2 and 7 and regulations of the DVGW [German association of gas and water specialists]). It is also designed to prevent calcification damage to water pipes, fittings, boilers and other equipment and to prevent malfunctioning.

Function

AQA Perla is a duplex softening unit that functions in accordance with the ion exchange principle. The unit is run with columns continually changing at short intervals. This method of operating ensures that softened water is even available during a regeneration procedure, while the frequent column change minimises stagnation times. In terms of chemical and microbiological parameters, this leads to significantly better water quality than with conventional alternating softening units. Regeneration is triggered volumetrically (depends on the quantity of water).

Very brief salt dilution times and short regeneration periods are achieved thanks to the special salt hopper for storing and dissolving salt.

The hardness of the drinking water and the desired hardness of blended water on-site is entered into the electronic system when the unit is started-up. All other unit parameters are stored in the electronic system. All unit data is preset and unit parameters can be queried. The remaining capacity is displayed in litres or in bar-graph form. The flow quantity is displayed in l/h during operation.

The unit is equipped with a device that disinfects the ion exchanger during the regeneration process. Spring-loaded non-return valves protect all water connections on the inlet side of the unit (in compliance with DVGW). This eliminates the need for a system or pipe isolator.

The system complies with all relevant national and international standards.

Electrical power failure

In case of an electrical power failure of more than 8h the softener restarts with an automatic regeneration of both columns.

All settings are permanently stored and do not have to be reentered after an electrical power failure.

Installation Requirements

Observe all applicable installation regulations, general guidelines, hygiene requirements, and technical specifications.

Softening systems may not be installed in water supply systems which provide water for fire extinguishing purposes.

The pipe network must be flushed before the unit is installed.

The hard water to be fed into the unit must always meet the specifications of the German drinking water regulations or EU directive 98/83 EC. The total dissolved iron and manganese may not exceed 0.1mg/l. The hard water to be fed into the unit must always be free of air bubbles; if necessary, a bleed device must be installed.

Continuous operation of the softening unit with water containing chlorine or chlorine dioxide is possible if the concentration of free chlorine/chlorine dioxide does not exceed 0.5mg/l.

However, continuous operation with water containing chlorine/chlorine dioxide causes the ion exchanger resin to age prematurely. A softening unit reduces the concentration of free chlorine and chlorine dioxide. In other words, the concentration in the outflow of a softening unit is generally considerably lower than in the inflow.

The unit should be sized so that at least daily regeneration is necessary based on the throughput. If water consumption is reduced, e.g. during holidays, a shut-off device must be fully opened for at least 5 minutes before water can be used again (DIN 1988 sections 4 and 8).

Use corrosion-resistant pipe materials for installation. Observe corrosion-causing chemical properties in the combination of different pipe materials (mixed installation), even in the direction of the flow upstream of the softening unit.

A protective filter must be installed no further than **1m** upstream from the unit. The filter must be functional before the water softening unit is installed. This is the only way to ensure that dirt and corrosive products cannot enter the softener.

You must check whether a mineral dosing device should be installed downstream from the unit for the purpose of preventing corrosion.

When installing the unit, select a location where the unit can easily be connected to the water supply network. A connection to the sewage system (at least DN50), a floor drain and a separate mains socket (230V/50Hz) must be nearby.

The emission of interference (voltage peaks, high-frequency electromagnetic fields, interference voltages, voltage fluctuations, etc.) by the surrounding electrical systems may not exceed the maximum values specified in EN 61000-6-4.

The rated mains power (230V/50Hz) and the requisite operating pressure must be present at all times. A separate means of protection against a lack of water is not provided and must be installed on-site if required.

If no floor drain and/or structural waterproofing compliant with DIN 18195-5 is present, a separate safety device (e.g. a hydrostop) must be used.

The installation site must be free of frost and kept free of chemicals, paint, solvents and fumes, and the ambient temperature must not be too high.

If the softened water is intended for human consumption as defined in the German drinking water regulations, the ambient temperature must not exceed 25°C. **If the softened water is intended for technical purposes only, the ambient temperature must not exceed 40°C.**

The hose attached to the overflow of the brine container and the flushing water hose must be routed at an incline to the sewage system or connected to a pump. **Note:** According to DIN 1988, the flushing water hose must be secured at a distance of at least 20mm from the highest possible waste water level (free discharge).

If flushing water is fed into a pump, it must be designed for a water quantity of at least 2m³/h or 35 l/min.). If the pump is used for other units simultaneously, it must be sized larger by a factor of their water output quantities. The pump must be salt-water resistant.

The maximum operating pressure of the unit must never be exceeded (see technical specifications). If the network pressure is higher, a pressure reducer must be installed upstream from the unit.

The unit requires a minimum amount of pressure to function (see technical specifications).

During pressure fluctuations or surges, the sum of the pressure surge and the standing pressure is not to exceed the nominal pressure. The positive pressure surge must not be greater than 2 bar and the negative pressure surge must not be less than 50% of the self-adjusting flow pressure (refer to DIN 1988 Part 2.2.4).

Warranty exclusion

- Non-compliance with the installation conditions and/or the operator responsibilities voids the warranty.
- The wearing parts as outlined in the "Operator Responsibilities" chapter and the consequences of failing to replace these parts on time is not covered by the 2-year legal warranty.
- BWT does not assume responsibility if the unit fails or if the capacity becomes deficient due to incorrect material selection/combination, floating corrosive products or iron and mineral deposits, or any resulting damage thereof.
- Using regenerative that does not comply with DIN EN 973 type A voids the warranty.

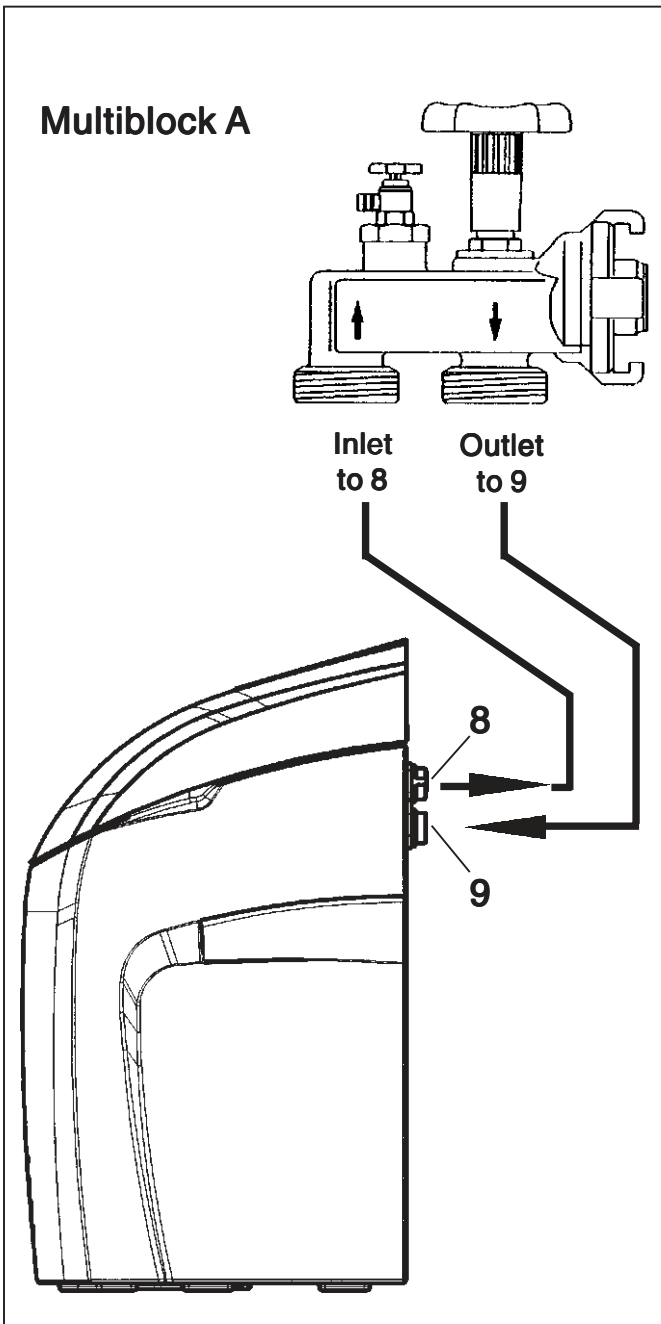
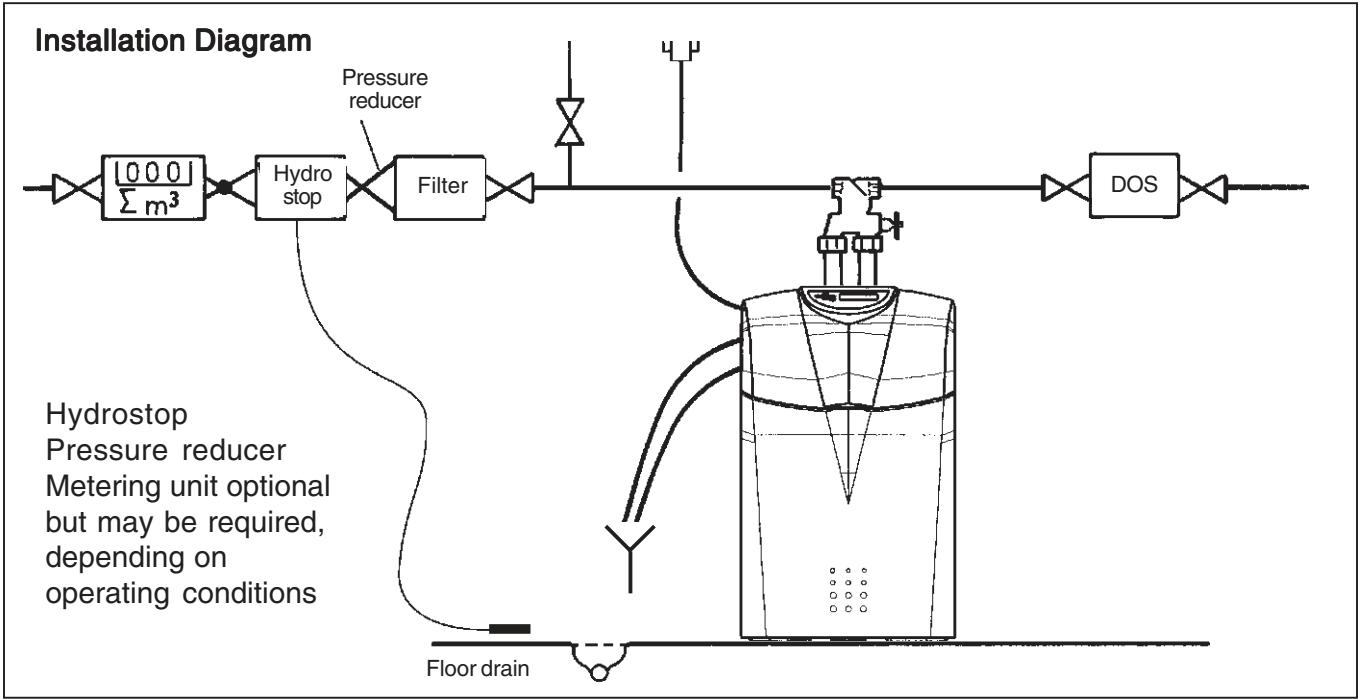

Installation

Connect the unit according to the adjacent diagram.

A bypass is integrated in multiblock module A.

Installation is possible in horizontal or vertical pipelines.

Follow the separate installation instructions, otherwise the warranty is void should the unit be damaged.

Flush out any dirt particles by opening the handwheel on the multiblock module.

Connect a corrugated hose to the multiblock module **outlet** and the **hard water inlet (9)**. **Be sure to observe the arrows indicating the direction of flow.**

Connect a corrugated hose to the multiblock module **inlet** and form a watertight seal with the **softened water outlet (8)**.



11

12

Insert a flushing water hose (11) into the Y-piece.

Route the flushing water hose (11) at an incline to the sewage system connection (drain) and secure the end with the fixing material supplied to prevent it flapping about when under pressure.

Put the overflow hose (18 x 24) on the overflow (12). Secure it with zip ties and route it with an incline of least 10cm to the sewage system connection (drain).

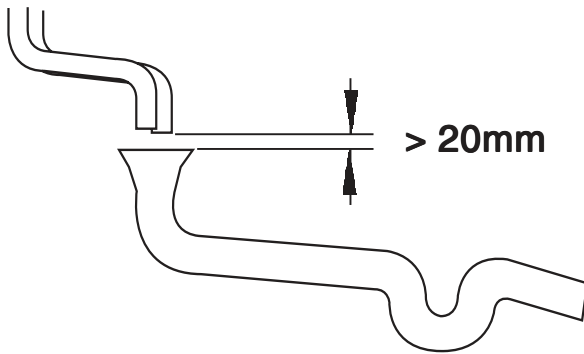

The two hoses connected to the sewage system may not be connected or constricted at any point.

Note: According to DIN 1988, the flushing water and overflow hoses must be connected to the sewage water system at least 20mm above the highest waste water level (free discharge).

Operation and control unit displays

Confirms entries Moves cursor, changes entries

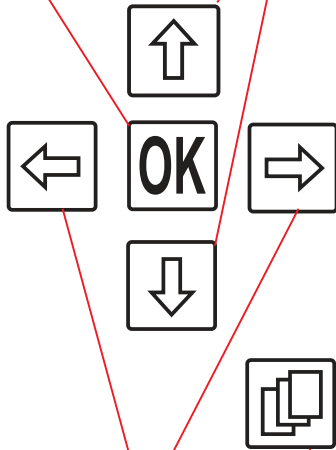

Moves cursor

The Browse button toggles between the Operating and Selection display

Operation display

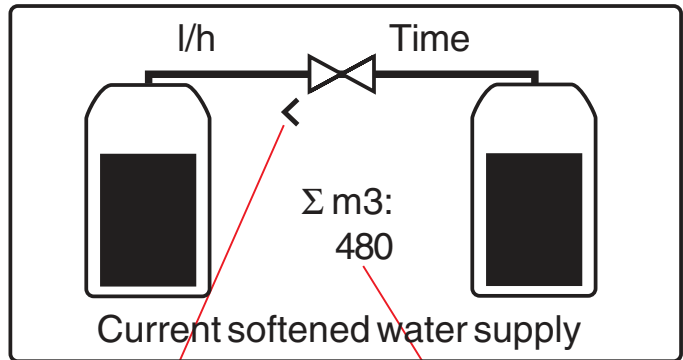

This column is in operation

Water consumption since start-up

Set the time and date

Change language

Trigger regeneration, column change and quick flushing

Selection display

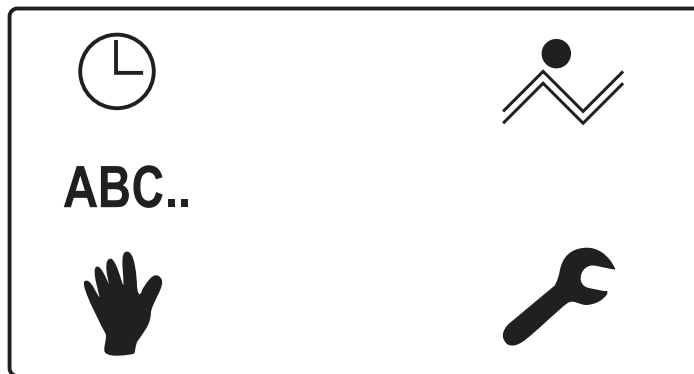

Set the hardness of drinking and blended water

After-sales service staff only

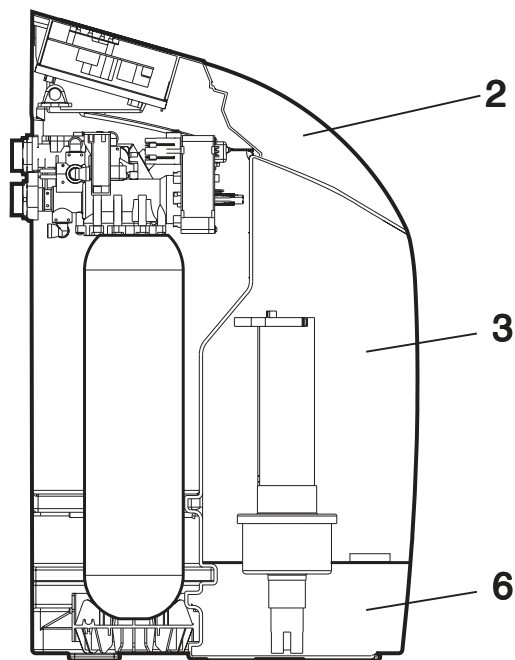

Start-Up

Check that the unit has been properly installed (according to DIN 1988, part 4).

Measure and note the hardness of the drinking water upstream of the softener with AQUATEST.

Preparing the brine

Remove cover (2).

Pour two sacks of regenerative (salt tablets according to DIN EN 973 type A) into the supply cavity (3).

Pour drinking water into the brine cavity (6) until the water-level is about 5-10 cm above the sieve base.

Note: Observe the following if there is a large quantity of untreated water after start-up: The unit requires approx. 3 hours for the brine to form.

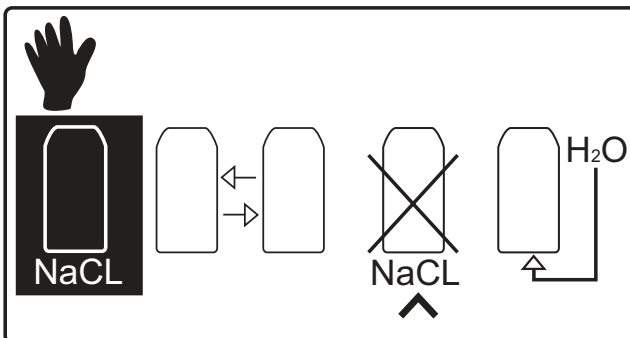
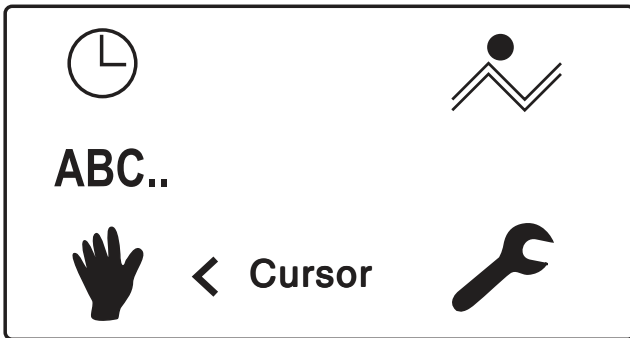
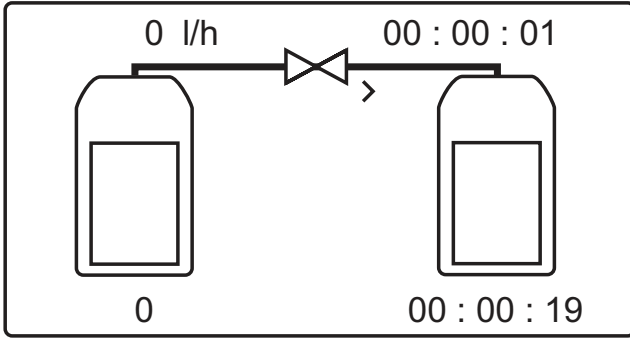

Regeneration
 Column change
 Cancel regeneration

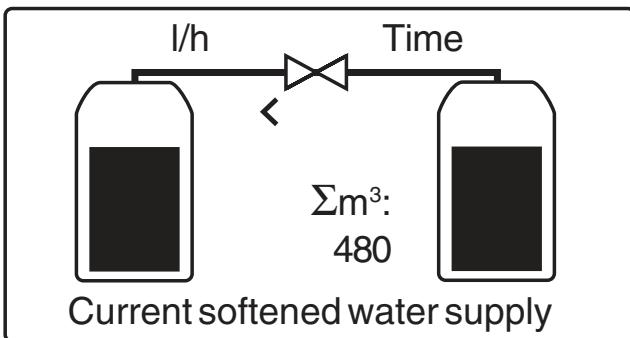

Insert mains plug.

Water supply must remain closed. The display shows the **Start screen** with the version number.

Allow basic fixing to finish (approx. 40sec.). The running noise stops.

The **regeneration** diagram appears; a **regeneration** begins.

Cancel regeneration.



Press the **Browse** button



Set the cursor to **Manual**



Press **OK**



Set the cursor to **Cancel regeneration**



Press **OK** to confirm for **the 1st column**



Press **OK** to confirm for **the 2nd column**
The regeneration is cancelled.



Press the **Browse** button twice



The current water flow, the time and the supply of softened water are now displayed.

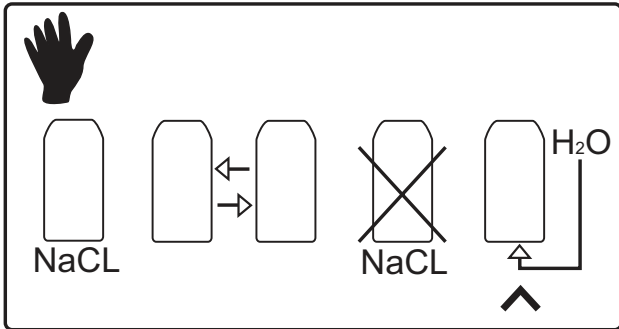
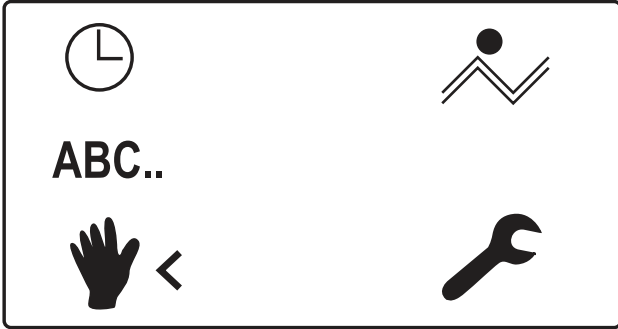
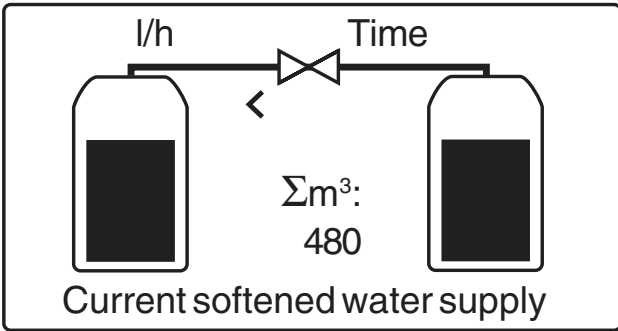

Initial start-up flush

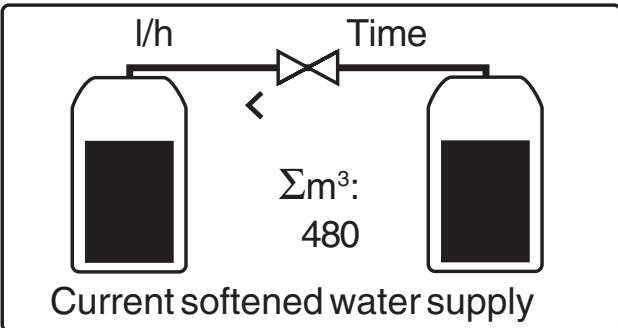

Start-up flush

Slowly turn on the water supply (multiblock).



Press the **Browse** button.



Set the cursor to **Manual**.



Press **OK**.



Set the cursor to **Start-up flush**.



Press **OK** to confirm.

The **Start-up flush** symbol is inverted.

The **start-up flush** begins automatically and lasts for approx. 6 minutes. Both softening columns are repeatedly flushed during this time.

No water can be removed during this time.

The display switches to the operating display after approx. 3 minutes.

The **start-up flush** ends when the water stops flowing.

Setting the hardness of water

The hardness of drinking water measured on site and the desired hardness of blended water is entered here.

The blending valve must also be adjusted (page 14).

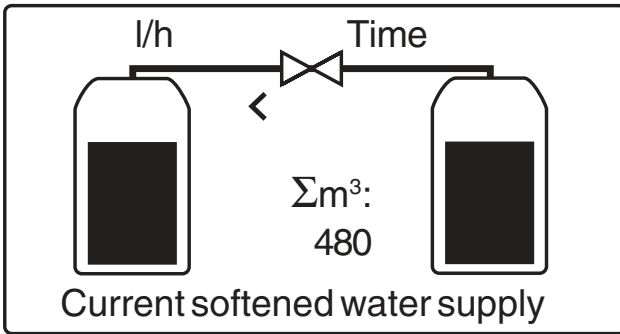

Press the **Browse** button.



Set the cursor to **Settings**.



Press **OK**.

You can make the following settings here:

The **blended water supply** can be displayed in **litres, m³ or US gallons**. Water hardness can be displayed in **°dH, °fH, °eH, CaCo₃ (ppm)**.

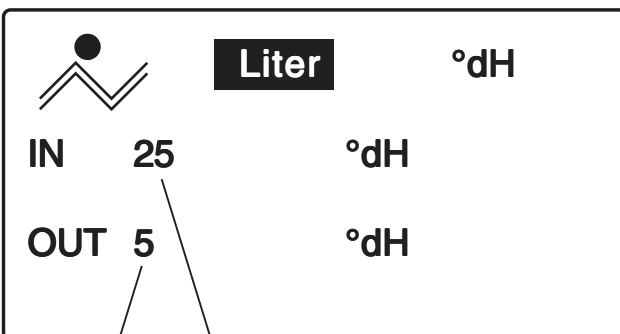

IN Hardness of drinking water
Enter the measured hardness of the drinking water.

OUT Hardness of blended water
Enter desired hardness of the blended water (BWT recommendation 4°-8°dH).

Enter hardness of water



Move the arrow horizontally to the required field.
The field is highlighted.



The value or the unit can be changed with the up/down arrows.

The changed values are saved immediately.



Press the **Browse** button twice.



The programming necessary for starting the unit is complete.

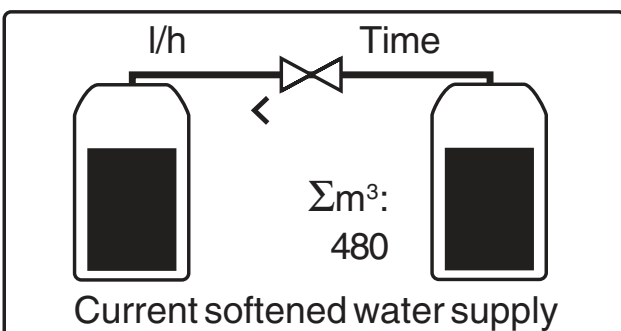

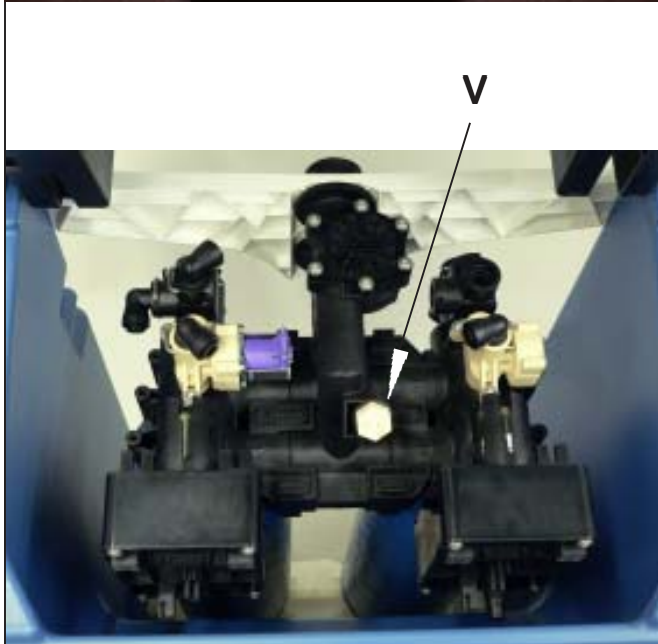

Setting the hardness of blended water

Remove cover (2).

Remove 2 plastic screws.

Swing the flap with the electronic system up and hold.

The blending valve (V) is located here.

Close the blending valve clockwise and then increase the blended water hardness by opening gradually (increasing arrow).

To test the water hardness, allow the nearest cold water tap to run for a while and check the hardness of the blended water using the AQUATEST hardness tester. Adjust with the blending valve (V) until the desired value (BWT recommendation 4°-8°dH) is reached.

The German drinking water regulations stipulate a sodium limit of 200mg/l. This limit has been set so low so that people on a low sodium diet can still drink water from the unit and use it for cooking.

Sodium content of partially softened water

The sodium content increases by 8.2mg/l if the hardness of drinking water is decreased by 1°dH.

Hardness of drinking water – hardness of blended water x 8.2mg/l = increase in the sodium content.

Check connections and pipeline junctions for leaks once again.

The unit is now ready for use.

Transferring the unit to the operator:

If there is a delay between the installation/start-up of the unit and transfer to the operator, a manual regeneration must be performed.

The operator must be told how the unit works as well as how to operate and inspect it. Ensure that the operator receives the installation and operating manual.

You can use this list to check your work again after installing and starting the unit.

Checklist

for proper installation by a qualified fitter

GB

- Has all packaging material been removed from the brine cabinet?
- Is there a protective filter upstream from the unit in the immediate vicinity?
- Is the water and power supply to the unit continuous (at least 2 bar network pressure)?
- Have you opened the multiblock to the limit stop?
- Have the connection hoses been properly connected? (Observe flow direction arrows, drinking water inlet at the non-return valve of the unit).
- Have you filled the unit with 20 litres of water?
- Have the flushing water hose and the overflow been routed separately to the sewage system and connected in compliance with DIN standards? (See Installation)
- Have you entered the drinking water hardness and set the blended water hardness on the blending valve correctly? (See Start-Up)
- Is the unit metering the blended water supply? (Open the tap downstream from the unit and observe the meter of the blended water supply counting down on the display)
- Have you filled out the machine log on the back page of this manual?
- Have you informed the operator of the inspection schedule required to comply with DIN 1988? (Check supply of salt and blended water hardness at least every two months)
- Have you informed the operator of the maintenance schedule required to comply with DIN 1988?
(Tasks in accordance with manufacturer's instructions. Frequency according to DIN 1988 - annually, semi-annually for communal units)

Operation

Please note that there is a separate manual for the multiblock module and connection set DN 32/32.

Manually start regeneration

Press the **Browse** button.

Set the cursor to **Manual**.

Press **OK**.

The cursor is set to **Regeneration**.

Press **OK** to confirm.

Regeneration of the currently active column is performed. The other columns control the soft water supply.

Press the **Browse** button twice.

Each stage of the regeneration process is displayed with the progressing time. Regeneration takes 17 minutes.

Additional disinfection is not required if the columns are regenerated regularly (by the quantity controller or time override controller). In unfavourable conditions, e.g. if the unit is located in a warm room and hasn't been used for a long time, it may need to be disinfected by staff from our after-sales service in addition to regeneration.

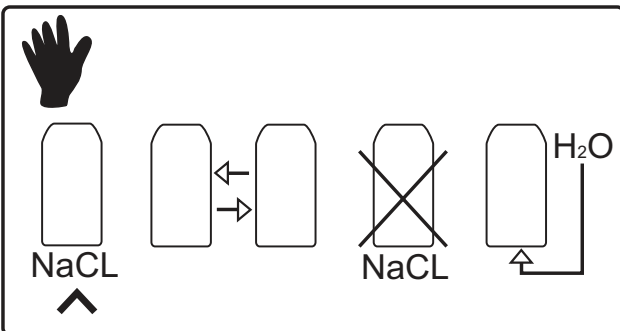

Regeneration

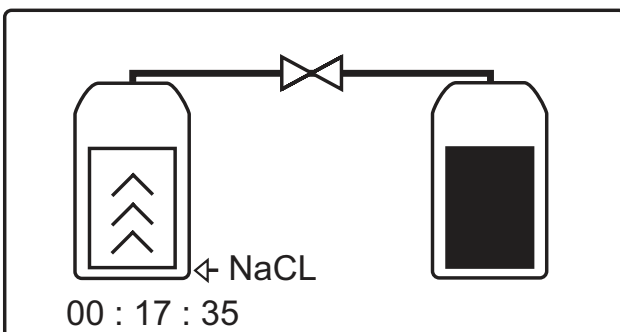
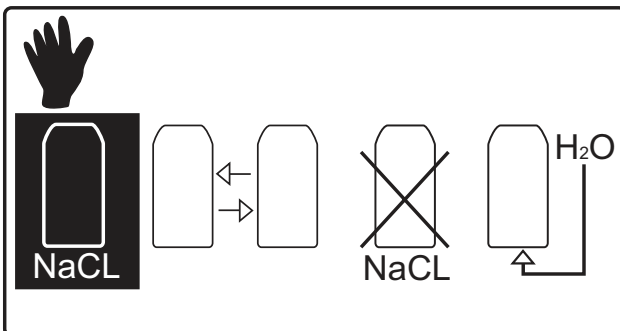

Fill regenerative

Refill the regenerative as soon as the sieve base (5) becomes visible or when **low-salt** is indicated on the display. All commercially available regenerative salts (boiled salt or tablet form according to DIN EN 973 type A) can be used.

Open cover (2). Fill regenerative in the storage area (3).

OK

Press the key. The **low-salt** display goes out.

The first two regenerations after a low-salt level is detected take an additional 5 minutes to complete.

Refill the unit in such a way that no dirt can get into the storage area (3) (if necessary, clean the regenerative packages before use).

Clean the storage area (3) or brine cavity (6) with drinking water if dirt does get in.

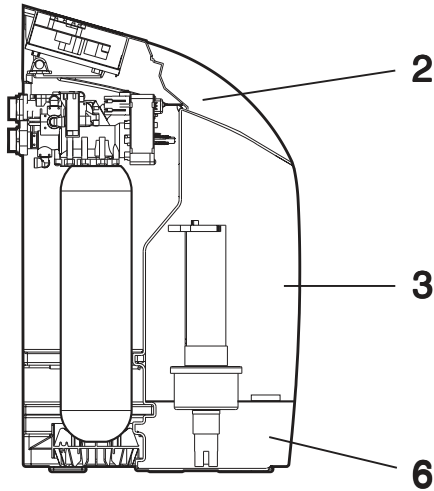

Valve 1 – 2 fuse!
Date Time



Electrolysis fuse
Date Time

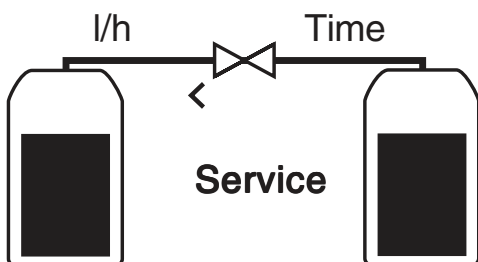

Current softened water supply

Fault messages

Valve/motor 1 or 2 faulty

Press **OK** to confirm.

Contact the after-sales service staff if the malfunction is still displayed.

Electrolysis cell overcurrent

Press **OK** to confirm.

Contact the after-sales service staff if the malfunction is still displayed.

Note: If there are any problems, pull out the mains plug and turn the handwheel on the multiblock module to close it to the limit stop (this releases the bypass to the water supply).

Service

Service is required after 500 regenerations or 12 months.

The new counter begins after 1m³ has flown through the unit.

Changing the national language

Only change this setting if another language is required.

Press the **Browse** button.

Set the cursor to **ABC..**

Press **OK**.

Place the cursor on the required language.

Press **OK** to confirm.

The language selected is highlighted.

Press the **Browse** button twice.

Display: Current softened water supply

Setting the time

The time is preset and automatically resets to daylight savings time (* after the time).

Press the **Browse** button.

Set the cursor to **Time**.

Press **OK**.

Move the highlighted display field further. Only the highlighted field can be changed.

Change numbers or display field.

24 h = 24 hour display

DS = Daylight savings time yes / no

Press **OK** to confirm.

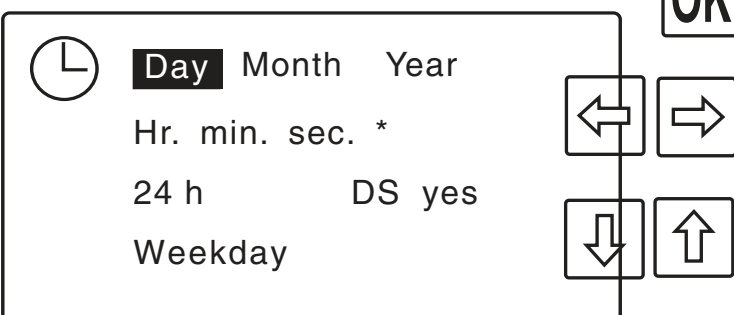
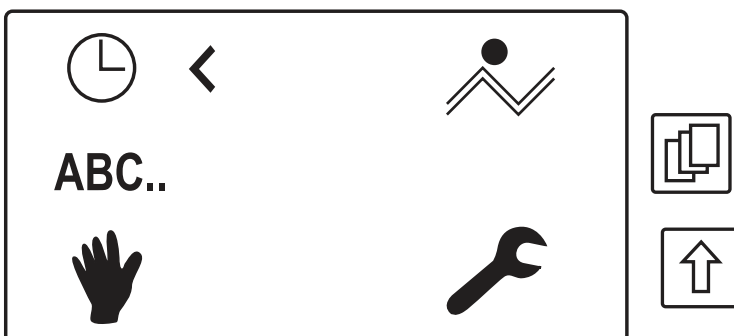
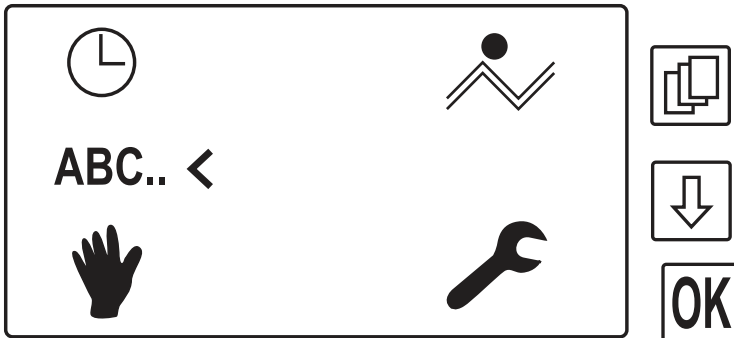

OK

Checks

The operator must perform the following checks regularly to guarantee that the unit functions properly.

Check the regenerative and refill after use

Check the water hardness

The hardness of drinking water entering the unit as well as the set hardness of the blended water must be checked once a month and corrected if need be (see Start-Up).

Check for leaks, visual inspection

Check connection lines and connections for leaks. Check for dirt in the storage area for regenerative and brine cavity every 2 months and flush with clear water if necessary.

The intervals between checks are recommended minimums and must be reduced accordingly for sensitive consumer systems.

Warranty

If the product malfunctions during the warranty period, please contact your contract partner, the installation company, and indicate the model type and production number (see specifications or the type plate on the unit).

Operator Responsibilities

You have purchased a durable and service-friendly product.

However, all technical equipment requires regular servicing to guarantee optimal functionality.

Find out about the quality/pressure ratio of the water to be treated on a regular basis. If the water quality changes, the settings may need to be changed. Consult a specialist if this is the case.

Hygienic cleaning of brine container cabinet at least once per year

Regular inspections by the operator and the replacement of wearing parts are required for the warranty and proper functioning of the unit. In accordance with DIN 1988 section 8 appendix B, the unit must be inspected regularly or, at the latest, every 2 months depending on service and operating conditions.

The replacement of wearing parts within the prescribed maintenance intervals is also required for the warranty and proper functioning of the unit.

In accordance with DIN 1988 section 8 appendix B, the unit must be serviced once a year. Communal units must be serviced twice a year.

Wearing parts:	Retainer seals
Maintenance	
Inspect non-return valve	Once a year
Inspect brine valve	Once a year
Inspect electrolysis cell	Once a year
Check water meter	Once a year
Check low-salt level	Once a year
Check drive motor	Once a year
Check/clean/replace retainer seals	Once a year
Injector	Every 5 years
Electrolysis cell	Every 5 years
Water meter	Every 5 years
Brine valve	Every 5 years
Waste water hose	Every 5 years
Non-return valve	Every 5 years
Dilution unit	Every 5 years
Control valves incl. softening columns	Every 10 years

Wearing parts may only be replaced by qualified personnel (fitter or after-sales service).

We recommend that you conclude a maintenance agreement with your fitter or the after-sales service department.

Troubleshooting

GB

Fault	Cause	Action
Unit not supplying softened or blended water.	No regenerative in the storage area (3) . Power supply cut off. Blending adjusting spindle (V) not set correctly.	Refill regenerative and start manual regeneration. Establish electrical connection. Set as described in Start-Up section "Setting the hardness of blended water".
Unit not supplying sufficient water or the flow is insufficient.	Inlet pressure is too low.	Increase admission pressure (set pressure reducer if necessary) and start manual regeneration.
The empty indicator lights up, although there is sufficient regenerative.	A cavity has been formed above the contact switch on the sieve base.	Mix the regenerative well by hand in the brine cabinet.
Coloured flushing water at start-up.	Abraded particles from ex-changer resin.	Repeat start-up flush.

If the fault cannot be remedied by following these steps, please contact our after-sales service department and quote the series and production number (see type plate on back of unit).



Standards and Legal Regulations

In the newest version

GB

The following standards and legal regulations must be observed depending on the intended use:

General administrative regulations on the minimum requirements on introducing waste water into bodies of water (administrative regulation on waste water) Appendix 31 Water treatment, cooling systems, production of steam

Law promoting economic resource management and ensuring the environmentally friendly disposal of waste (resource management and waste law)

Federal Water Act

Water quality regulations for human consumption (German drinking water regulations)

EN 806, Specifications for installations inside buildings conveying water for human consumption

DIN 1988, Technical regulations for drinking water supply systems

DIN EN 1717, Protection of drinking water from contaminants in the drinking water supply system

The unit conforms to DIN EN 14743, systems for handling drinking water in buildings - softener and DIN 19636-100, softeners for drinking water installation – part 100: Requirements for application of softeners in accordance with DIN EN 14743.

Technical Specifications

GB

Water softening unit	Model	AQA Perla
Nominal connection width	DN	32 (G 1¼")
Nominal pressure	PN	10
Operating range	bar	2 - 8
Nominal flow in accord. with DIN 19636 (EN 14743)	l/h	1700 (1400)
Pressure drop at nominal flow in accordance with DIN 19636 (EN 14743)	bar	0.8 (1.0)
Rated capacity to DIN 19636 (EN 14743)	mol	2 x 1.3 (2 x 1.2)
Quantity of resin	l	2 x 5.4
Regenerative consumed per regeneration	kg	0.25
Sewage amount per regeneration at 2 (5) bar	l	16 (26)
Regenerative storage capacity in the cabinet	max. kg	50
Mains power	V/Hz	230/50 - 60
Energy requirement	W/h	15
Unit voltage	V~	24 / 6
Protection class	IP	54
Water/ambient temperature min/max	°C	2 – 30/40
Dimensions (H x W x D)	mm	890 x 500 x 520
Connection height A1 and A2	mm	635 and 690
External thread connection		G 1¼"
Minimum sewage system connection	DN	50
Empty weight excl. packaging, approx.	kg	29
Production number	PNR	6-500050

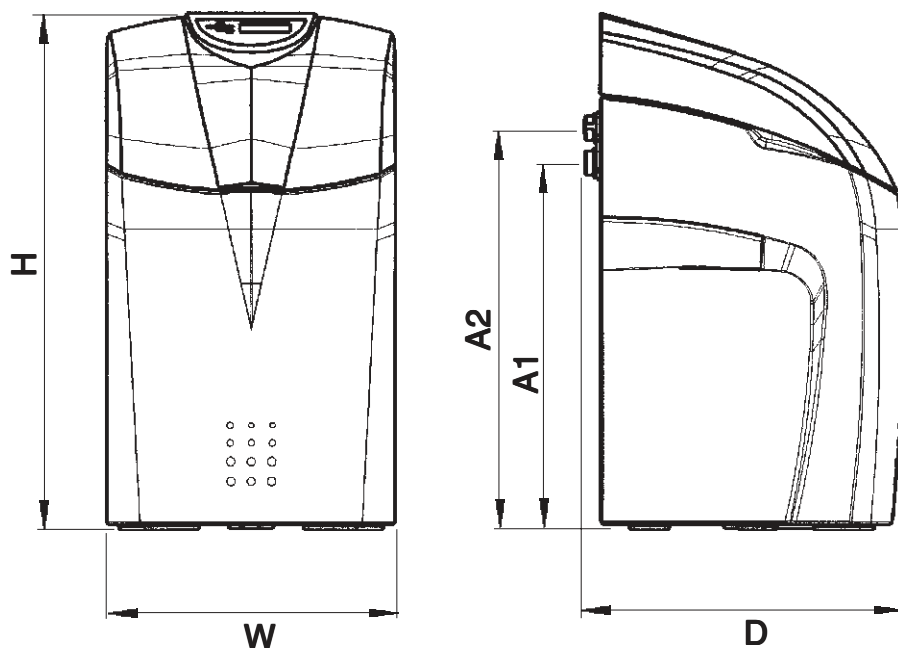

Machine Log

(to be filled in when starting the unit)

Drinking water hardness inflow _____ °d
Date of initial start-up _____

Network pressure _____ bar

Water meter status _____ m³

Personnel trained _____

Regenerative refilled																				
Maintenance performed																				
Date/name																				
Regenerative refilled																				
Maintenance performed																				
Date/name																				

Comments _____

Contact

BWT UK Limited

BWT House, The Gateway Centre,
Coronation Road, High Wycombe,
Buckinghamshire, HP12 3SU

Tel: 01494 838 100

Email: sales@bwt-uk.co.uk

BWT 2011 in the interests of product development we reserve the right to alter specifications without prior notice. All photographs and dimensions are given for guidance only. Terms and conditions apply E&OE.

ME1142