



PM200S  
Powermag 2"

**NEW Powermag Electromagnetic Scale Inhibitor - Stainless Steel Core**

Performance	
Field line angle	360° Degree
Magnetic flux density	2,500 Gauss
Conditioning	100%
Effective treatment	'Instant' conditioning
Approval	WRAS
Coil voltage	16 Volts DC
Mechanism to prevent regular maintenance	Unrestricted flow path creating powerful self cleaning effect
Power consumption	0.2 kW
Flow rate	6.0 Litres / Seconds
Pressure drop	Less than 4.7 mBar
Specifications	
Pipe connection	2" Male BSP
Coil diameter	324mm
Coil Width	225mm
Overall Length	330mm
Weight	20.4Kg
Max inlet pressure	16 Bar
Pressure Test	32 Bar
Power supply	230v/50Hz Single phase
EMF Emissions	Nil
Control panel	IP65
Construction	
Material	Stainless steel pipework

Control Panel	
Dimensions H X W X D	300 X 325 X 225mm
Weight	7.7Kg
Power Consumption	0.2kW



An electromagnetic physical water conditioner uses the principles of magnetism to inhibit formations of hard crystalline scale within hot and cold water services. The Powermag sets up a specific magnetic field which has an effect on the hardness salts within the water. This helps to inhibit and remove existing formations of scale, providing an environmentally friendly method of scale control without the use of chemicals

- 100 % Conditioning
- WRAS Approved
- Stainless steel pipework
- Nominal pressure drop
- Low power consumption
- Sizes available : 3/4" - 4"



Note the power consumption is related to the flux capacity of the unit chosen. The voltage supplied to the coil has been optimised to give the required gauss rating



# PM200S Powermag 2"

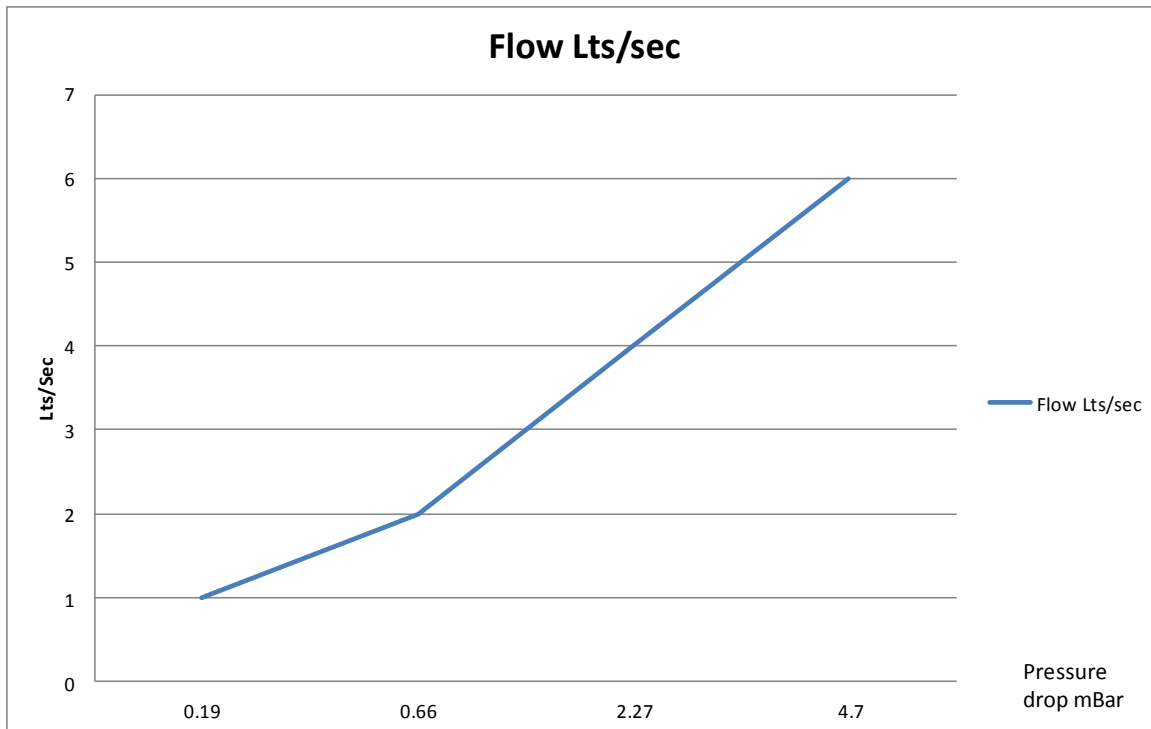

Inlet/Outlet connection  
2" BSP Male

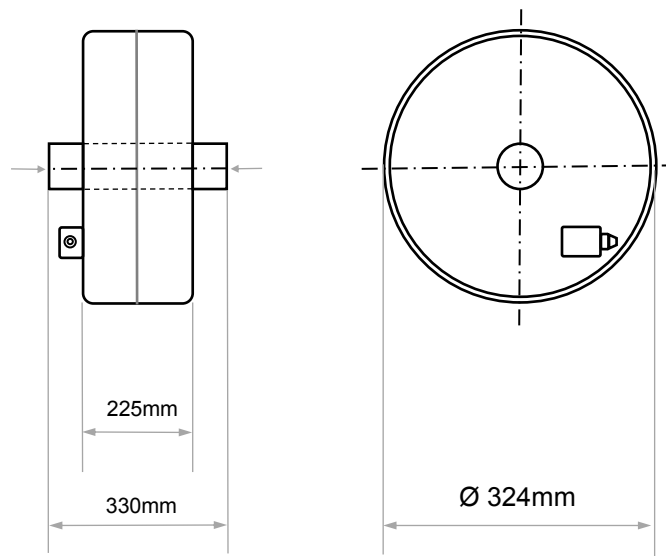

BWT endeavour to ensure that the information in this document is correct and fairly stated, but does not accept any liability for any error or omission. The development of BWT products is continuous and published information may be out of date. Please check with BWT UK for final specifications